

Lithium Manganese Dioxide Battery

CR1616

■ Dimensions (mm)

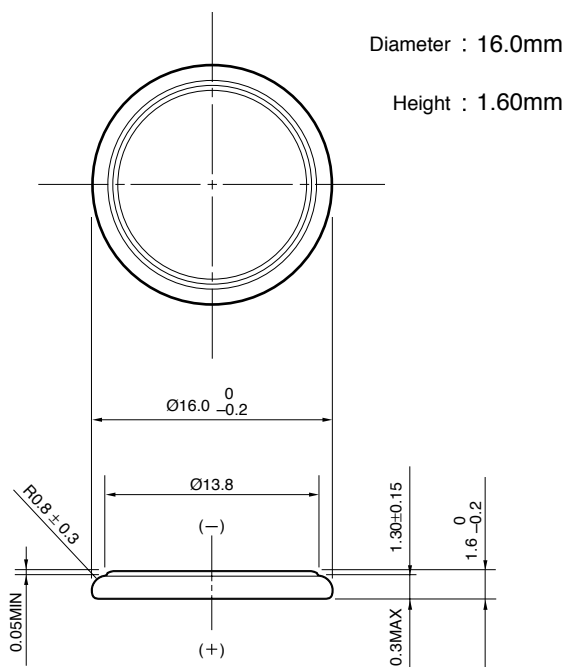

■ Specifications

Nominal Voltage	3V
Nominal Capacity (2.5V cutoff)	57mAh
Recommended Continuous Drain	0.1mA
Recommended Pulse Drain	5mA
Weight	1.1g
Applications	
<ul style="list-style-type: none"> ● Electronic Watch or Clock ● Electronic Calculator ● Memory Back-up Power Source for SRAM or Real Time Clock (RTC) 	

■ Discharge Characteristics

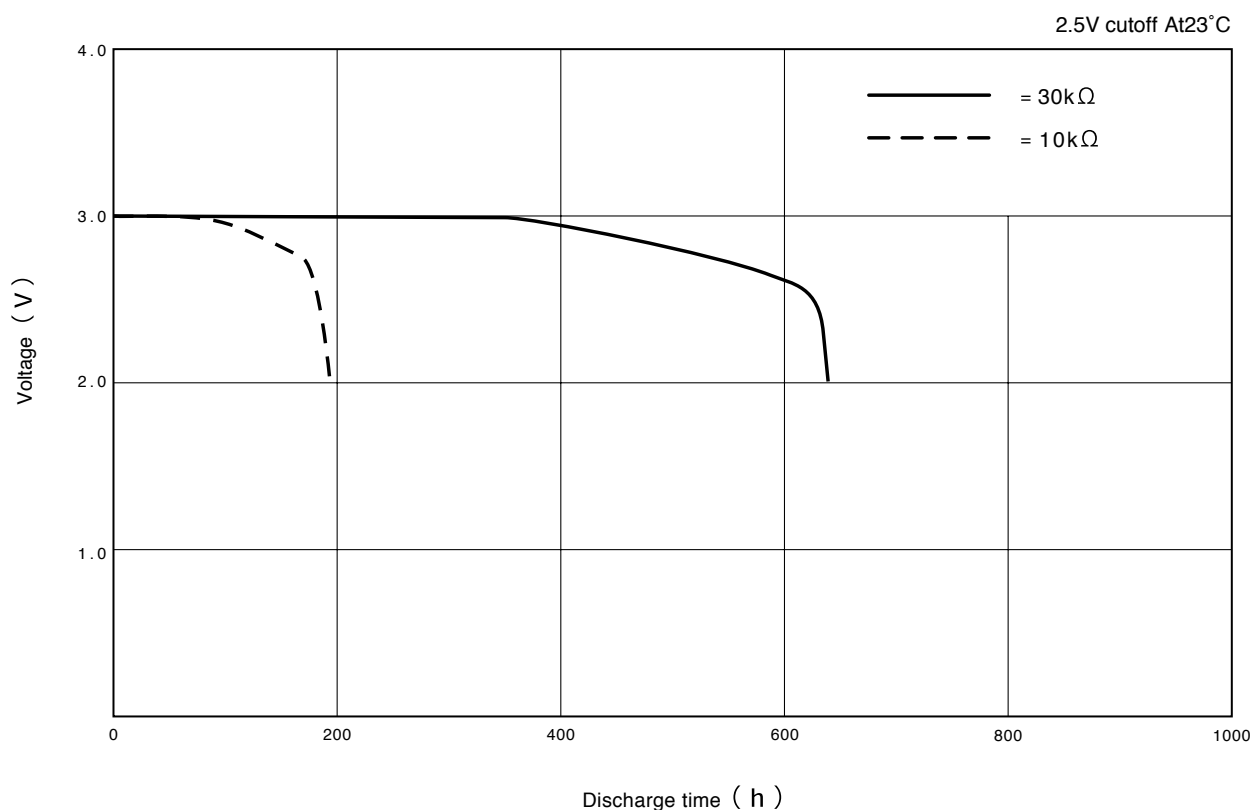

Discharge Characteristics on Load

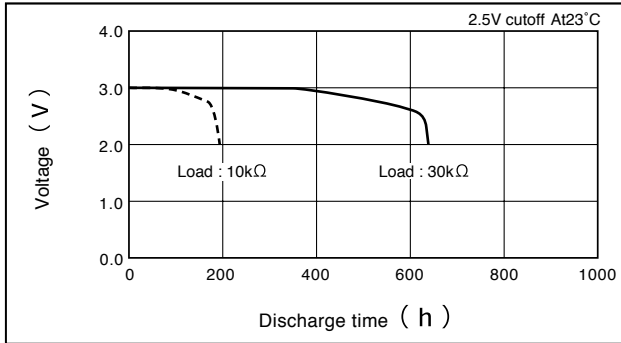

Discharge Characteristics on Temperature

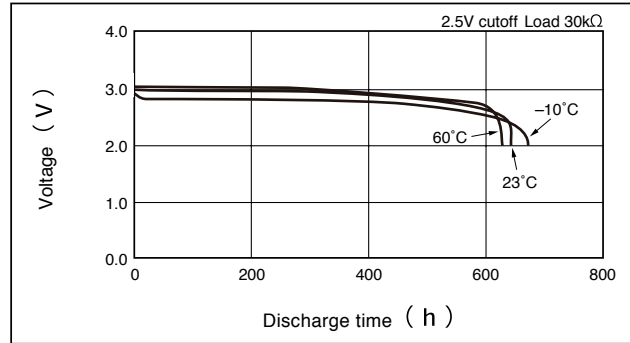

Discharge Load vs. Operation Voltage (Discharge depth 40%)

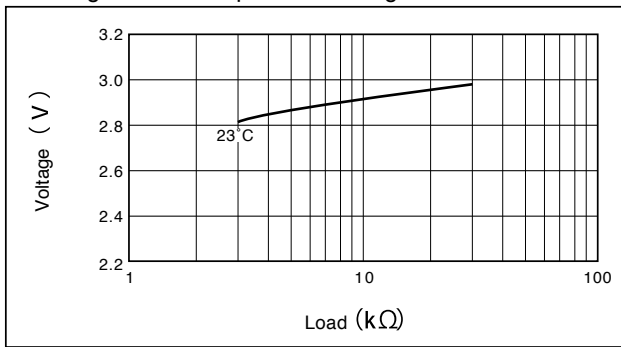

Discharge Load vs. Discharge Capacity

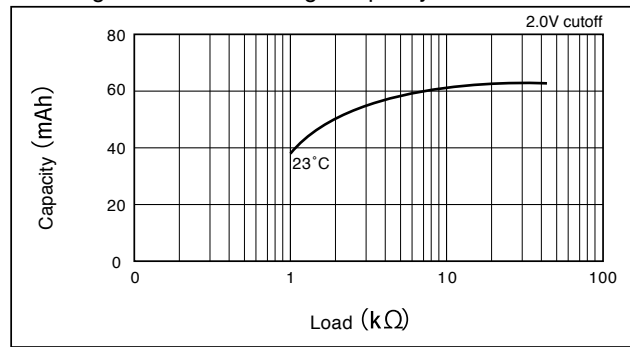

Discharge Characteristics on Pulse Load (Discharge depth 40%)

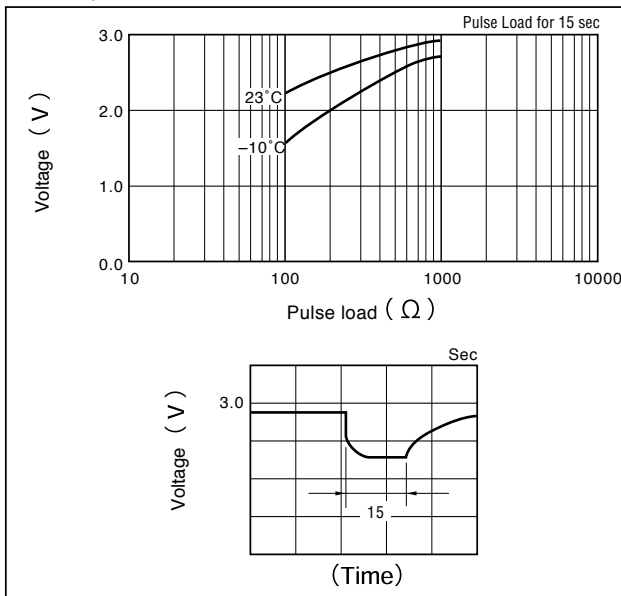

Storage Characteristics

