

CR1225

3V Lithium Battery
Swiss Made

Technical Data Sheet

Specifications

Chemical System	Li/MnO ₂
Nominal Voltage	3 V
Rated Capacity	48 mAh
Standard Discharge Current	0.1 mA
Max. Cont. Discharge Current	1.0 mA
Average Weight	0.9 g
Temperature Range	-30 - +70 °C
Self Discharge at 25 °C	< 1% / year

Dimensions

(According to IEC 60086)

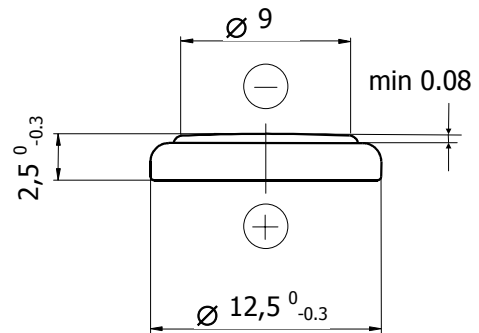

Performance

Discharge performance at 23°C

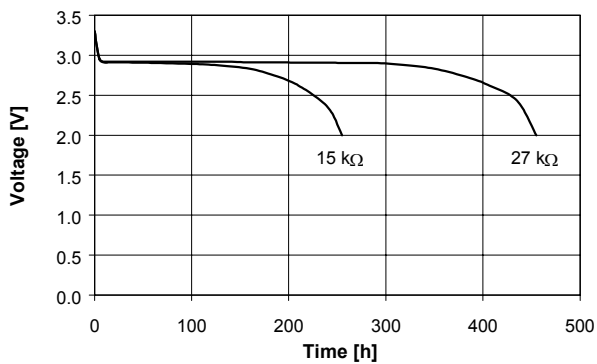

Discharge performance at 23°C

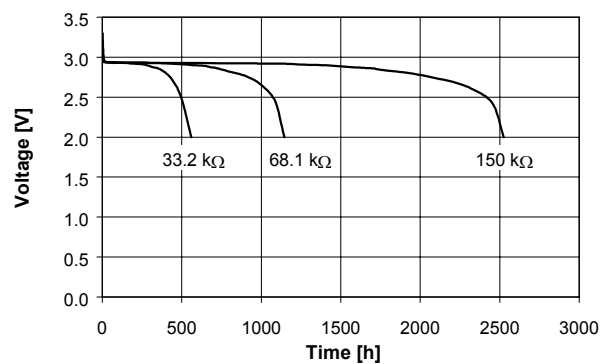

Temperature performance Load 27kΩ

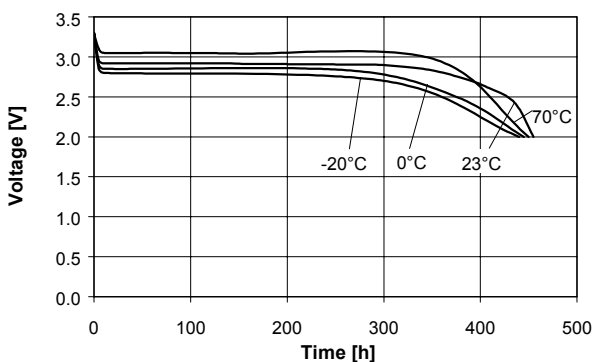

Cell capacity at various loads

