

Lithium Manganese Dioxide Battery

CR1220

■ Dimensions (mm)

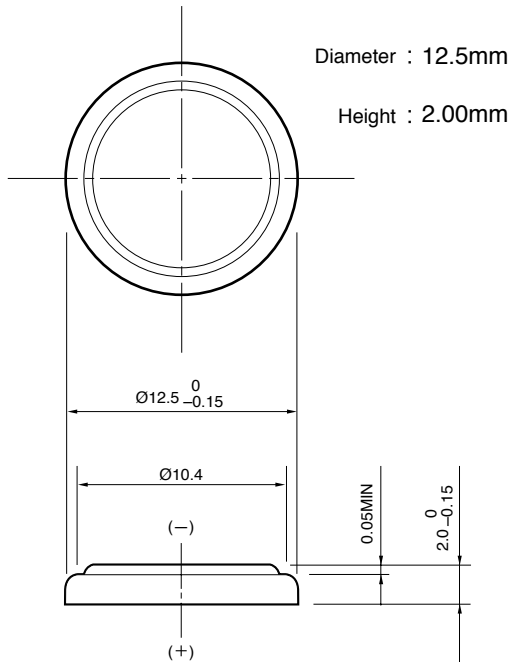

■ Specifications

Nominal Voltage	3V
Nominal Capacity (2.5V cutoff)	40mAh
Recommended Continuous Drain	0.1mA
Recommended Pulse Drain	5mA
Weight	0.8g

Applications

- Electronic Watch or Clock
- Electronic Calculator
- Memory Back-up Power Source for SRAM or Real Time Clock (RTC)

■ Discharge Characteristics

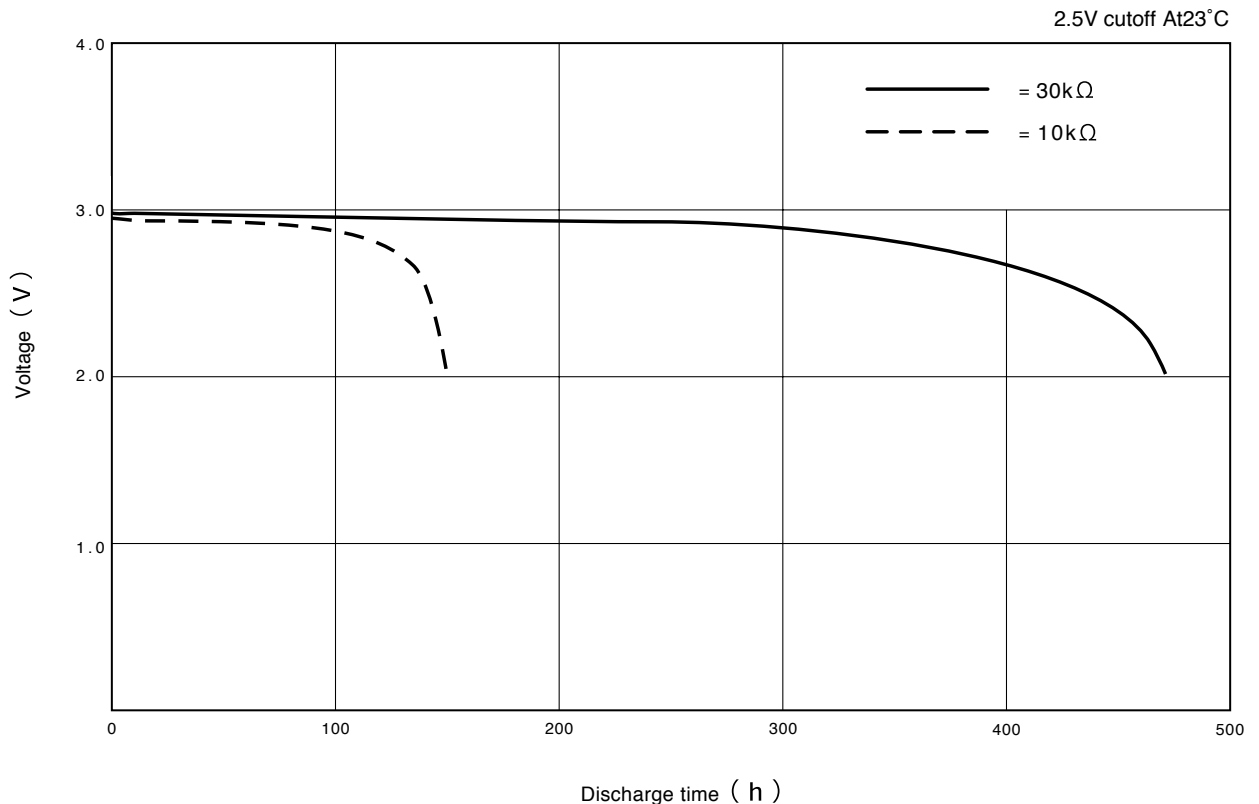

Discharge Characteristics on Load

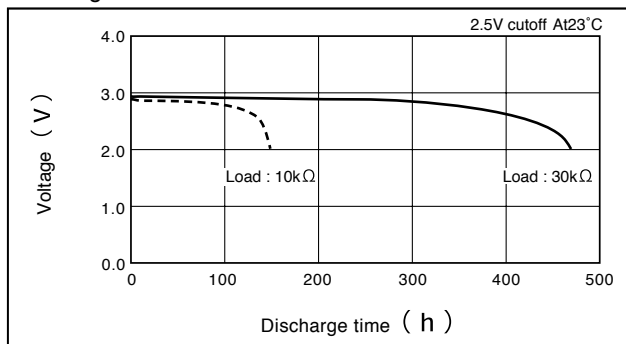

Discharge Characteristics on Temperature

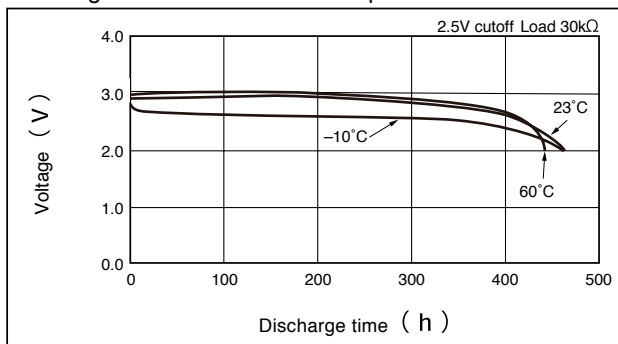

Discharge Load vs. Operation Voltage (Discharge depth 40%)

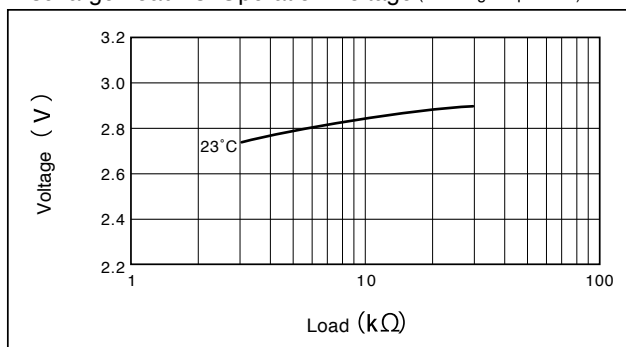

Discharge Load vs. Discharge Capacity

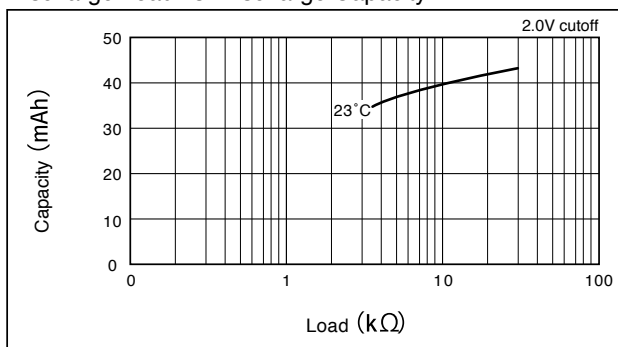

Discharge Characteristics on Pulse Load (Discharge depth 40%)

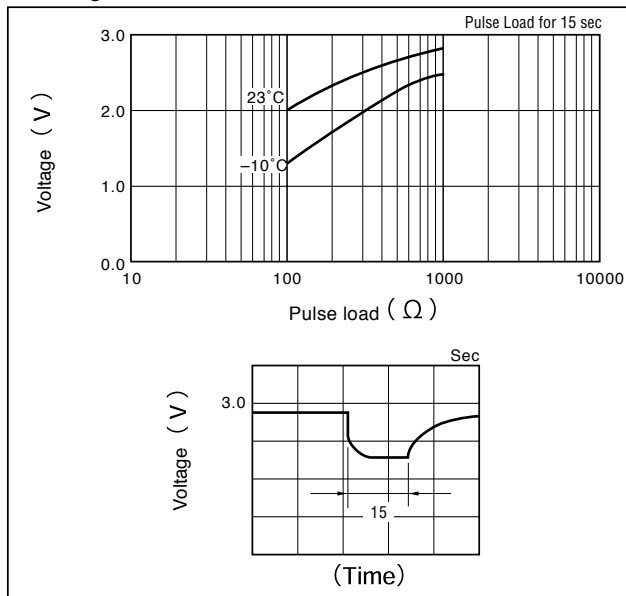

Storage Characteristics

